

# A Fuzzy Logic Concept Design for Improving the Angular Resolution of Permanent Magnet Stepper Machine

El Manâa Barhoumi, Kais Mhatli, Boujemâa Ben Salah

Ecole Nationale d'Ingénieurs de Tunis

Department of Electrical Engineering

BP. 37, le Belvédère, 1002 Tunis-Tunisia

E-mail: barhoumi\_manaa@yahoo.fr , mhatli\_kais@yahoo.fr , boujemaa.bensalah@enit.rnu.tn

**Abstract:** In this paper, is presented a fuzzy logic strategy in order to improve the angular resolution of the permanent magnet (PM) stepper actuator. Then, is described and discussed, in the first part, the conventional open loop microstepping technique which is realised by a Pulse Width Modulation. In the second part, a design of a new approach structured around the fuzzy logic controller is proposed. This control approach needs only the rotor position, which can be easily measured, to compute the control law. Finally, obtained simulation results are presented and discussed. These results confirm the efficiency of the proposed controller for the considerable improvement of the static and dynamic performances.

**Keywords:** Fuzzy logic controller, Microstepping, Permanent magnet stepper motor, Incremental torque, positioning error.

**El Manâa Barhoumi** received the Master degree in Electrical Engineering from the Ecole Nationale d'Ingénieurs de Tunis-Tunisia in 2008. He is a member of Laboratory of Electrical Systems (LSE) ENIT, Tunis- Tunisia.

**Kais Mhatli** received the Dipl.-Ing. and the M.Sc. degrees in Electrical Engineering from Ecole Nationale d'Ingénieurs de Tunis (ENIT), Tunisia, in 2000 and 2004 respectively. In September 2005, he joined the Institut Supérieur des Etudes technologiques de Radès (ISET Radès), Tunisia, as associate professor. He works now in the Ph.D. degree in the field of power systems design and control.

**Boujemâa Ben Salah** received the Master degree in Electrical Engineering from Ecole Normale Supérieure de l'Enseignement Technique de Tunis (ENSET) in 1986. Also, He received the *Doctorat and Habilitation Universitaire* (HDR) from ENIT in 1997 and 2003 respectively. From 1988 to 1997 he was employed at the ENIT as an Assistant. From 1997 to 2003, he has been Associate Professor in the same school. From 2003 up to now, he is a full professor in electrical engineering at ENIT Univ. Tunis. From 2000 he is currently a visiting professor in the Ecole Centrale de Lille-FRANCE. His main research interests are actuators design and control, power control, speed AC drives.

## 1. Introduction

The essential property of a stepper motor is the translation of the switching excitation changes into precisely defined rotor increments. Because of its precise open loop functioning, the PM stepper motor is used in many applications, ranging from simple applications to high end space applications such as positioning mechanisms for telescopes.

However, some oscillations and a long settling time of the position evolution are the main disadvantage of the PM stepper motor. Moreover, the oscillations can induce the PM stepper motor at some control frequencies to an erratic working. Also, the angular resolution of the PM stepper motor is small, but many applications require accurate positioning and a fine resolution.

In order to solve these problems, we propose in this paper a new closed loop control strategy based on the use of a fuzzy logic concept, which improve the angular resolution.

Fuzzy logic control (FLC) is mainly applied to complex plants where it is difficult to obtain accurate mathematical model or when the model is severely non linear. FLC has the ability to handle numeric and linguistic knowledge simultaneously. FLC gives good performances when it is applied to electrical machines.

This paper is organized as follow. The description and mathematical model of the PM stepper motor are presented in section 3. Section 4 is consecrated to the full step working. Section 5 and 6 are reserved to microstepping obtained by conventionally technique. The new proposed closed

loop fuzzy logic concept is developed in section 7. The validation and the commentary of this approach are also explained in this section. Finally, section 8 presents our conclusion.

## 2. Nomenclature

$\Omega$	:	rotor speed
$\theta_m$	:	motor position
$i_\alpha$	:	current of the phase $\alpha$
$i_\beta$	:	current of the phase $\beta$
$U_{\alpha\Box'}$	:	voltage of the phase $\alpha$
$U_{\beta\Box'}$	:	voltage of the phase $\beta$
$L$	:	auto inductance
$R$	:	resistance
$C_r$	:	load torque
$P$	:	number of pair of poles
$J_0$	:	rotor inertia
$D_{r0}$	:	viscous friction
$K_\varphi$	:	motor torque constant
$L_p$	:	amplitude of the variable component of inductance
$L_o$	:	average value of inductance
$P_z$	:	numbers of pair of teeth
$C_{INC}$	:	incremental torque

## 3. System Modelling

The basic structure of the stepper motor is shown in Figure1. It is composed by a stator having two phases denoted  $\alpha\alpha'$  and  $\beta\beta'$  and a bipolar electromagnet rotor. The choice of a ferromagnetic material electromagnet makes it possible to take into account the permanent magnet and a variable reluctance motors at the same time.

The stepper motor operates due to the reaction between a rotor and electromagnetic field produced by the winding stator. As obvious from intuition, the number of poles on the rotor and the number of stator winding determine the step angle.

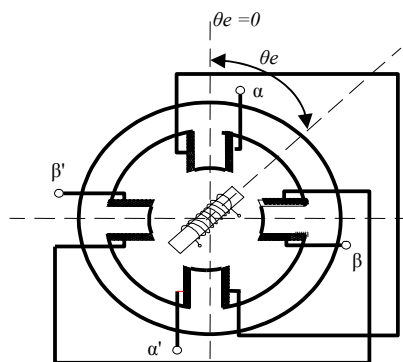

**Figure 1.** Basic structure of the stepper motor

The mathematical model of the generalized stepper motor is well known, [1, 2]:

$$U_{\alpha} = Ri_{\alpha} + [L_0 + L_p \cos(2p_z \theta_m)] \frac{di_{\alpha}}{dt} + L_p \sin(2p_z \theta_m) \frac{di_{\beta}}{dt} - 2k_r [i_{\alpha} \sin(2p_z \theta_m) - i_{\beta} \cos(2p_z \theta_m)] \Omega - [k_{\phi} \sin(p\theta_m)] \Omega \quad (1)$$

$$U_{\beta} = Ri_{\beta} + L_p \sin(2p_z \theta_m) \frac{di_{\alpha}}{dt} + [L_0 + L_p \cos(2p_z \theta_m)] \frac{di_{\beta}}{dt} + 2k_r [i_{\alpha} \cos(2p_z \theta_m) + i_{\beta} \sin(2p_z \theta_m)] \Omega + [k_{\phi} \cos(p\theta_m)] \Omega \quad (2)$$

$$C_{em} = -k_{\phi} [i_{\alpha} \sin(p\theta_m) - i_{\beta} \cos(p\theta_m)] - k_r [(i_{\alpha}^2 - i_{\beta}^2) \sin(2p_z \theta_m) - 2i_{\alpha} i_{\beta} \cos(2p_z \theta_m)] \quad (3)$$

For the permanent magnet stepper motor, the proper winding inductances don't depend on the rotor position. To increase the torque of this actuator, the two phases  $\alpha$  and  $\alpha'$  are often connected in series thus composing a single phase  $\alpha\alpha'$  fed in bipolar mode. Windings  $\beta$  and  $\beta'$  are also connected in the same way leading to a bipolar single phase  $\beta\beta'$ . Consequently, the dynamic model of the permanent magnet stepper motor is given by the following equations:

$$U_{\alpha\alpha'} = Ri_{\alpha\alpha'} + L_0 \frac{di_{\alpha\alpha'}}{dt} - k_{\phi} \Omega \sin(p\theta_m) \quad (4)$$

$$U_{\beta\beta'} = Ri_{\beta\beta'} + L_0 \frac{di_{\beta\beta'}}{dt} + k_{\phi} \Omega \cos(p\theta_m) \quad (5)$$

$$C_r = -k_{\phi} [i_{\alpha\alpha'} \sin(p\theta_m) - i_{\beta\beta'} \cos(p\theta_m)] - D_{ro} \frac{d\theta_m}{dt} - J_0 \frac{d\Omega}{dt} \quad (6)$$

$$\frac{d\theta_m}{dt} = \Omega \quad (7)$$

## 4. Full Step Functioning

The electromagnetic stepper motor is a structure where the rotor is a permanent magnet. The stator is composed by regular distribution of windings. The majority of the permanent magnet stepper motors are fed into bipolar. In such case, the windings  $\alpha$  and  $\alpha'$ ,  $\beta$  and  $\beta'$  are connected in series.

Without load, the rotor is positioned in the direction of the magnetic field created by the stator winding. However, to make turn the rotor of a first position to the following one, it is enough to shut off the current in the first phase and to establish it in the next phase. Also, the continuous motion is obtained by the cyclic excitation of the phases ( $\alpha\alpha'$ ) and ( $\beta\beta'$ ) by a positive current during the first two steps and by a negative current during the following steps. The inversion of this sequence makes turn the stepper motor in the opposite direction.

Always, in open loop control, the stepper motor position evolution presents an important overshoot and a long settling time, Figure 2:

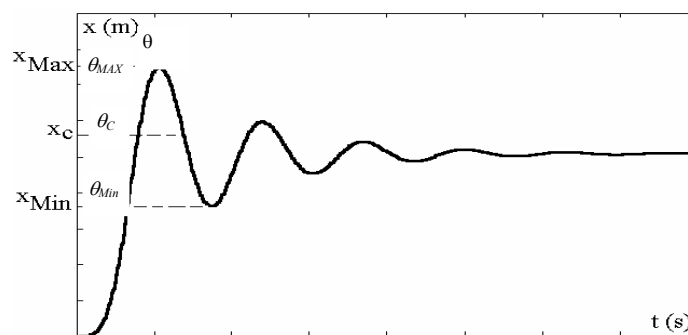

Figure 2. Single full step position response

These oscillations may induce dynamic instability problems and erratic functioning. In fact, this oscillation evolution varies between a maximum and minimum displacements, respectively  $\theta_{Max}$  and  $\theta_{Min}$ . Assuming that the commutation of the following displacement is set at  $\theta_c$  where the rotor, moving in a negative speed, have acquired kinetic energy  $W_c$ . In the interval  $[\theta_c - \theta_{Min}]$ , the propulsive effort, resulting from the difference between the electromagnetic torque  $C_{em}$  and the resisting torque  $C_r$ , must primarily reduce the effect of acquired  $W_c$ . The energy  $W_f$  needed to break the system is expressed as, [2]:

$$W_f = \int_{\theta_{Min}}^{\theta_{Max}} (C_{em}(\Omega) - C_r) d\Omega \quad (8)$$

and the condition of steady working is :

$$W_f > W_c \quad (9)$$

If this condition is not satisfied, the motor keeps its rotation in the reverse direction and gets in domains of erratic behaviour. According to the importance of the static and the dynamic friction, stepping motors can evince one or several instability domains. These domains may emerge either when the step duration is adjoining the natural period of oscillations or their multiples, or when the control frequency is closely related to the natural frequency or its sub-multiples.

In order to reduce these zones of resonance, it is necessary to attenuate the overshoot and deaden the oscillations of movement. This objective could be reached by an adequate control of the kinetic energy of the mobile part. So, in order to limit the evolution of this energy, we solicit the rotor to two antagonistic torques. The first torque provokes the advance of the mobile part in the positive sense. The second one breaks the movement of the rotor. Hence, the rotation will be operated in fragmented steps.

In order to produce these two antagonistic torques, we inject simultaneously two current intensities in two adjacent statoric windings. This microstepping control concept is conventionally realized by Pulse Width Modulation Technique (PWM).

## 5. Microstepping Control Principle

The full step size of the stepping motor can be divided into smaller increments of rotor motion by a particular partially exciting several phases. This microstepping technique is typically used in applications that require accurate positioning, a fine resolution and a smoother movement.

In order to obtain an intermediate position ( $\theta_j$ ) between steps, it is possible to control statoric field. Moreover, for a magnetic structure, the control of the statoric field orientation is performed by the choice of suitable average currents  $I_{\alpha\alpha'}$  and  $I_{\beta\beta'}$ . The applied currents for intermediate position are shown in Figure 3.

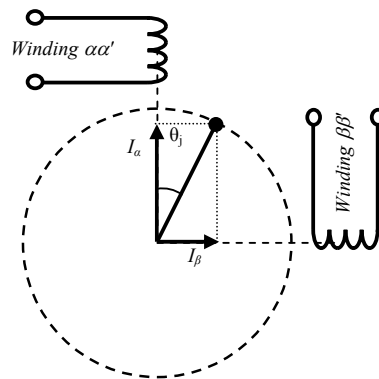

**Figure 3.** Applied currents for intermediate position

In this case the currents  $I_{\alpha\alpha'}$  and  $I_{\beta\beta'}$  have respectively the following expressions:

$$I_{\alpha\alpha'} = I_n \cos(\theta_j) \quad (10)$$

$$I_{\beta\beta'} = I_n \sin(\theta_j) \quad (11)$$

With  $I_n$  is a nominal current.

## 6. Microstepping by Conventional Technique

In order to subdivide the first mechanical step, the both phase windings ( $\alpha\alpha'$ ) and ( $\beta\beta'$ ) must be excited simultaneously. But the phase winding ( $\beta\beta'$ ) is excited by a PWM signal having a cyclic ratio progressively increasing. However the phase winding ( $\alpha\alpha'$ ) is excited by the complement of it signal which present an impulse width progressively decreasing. Consequently the first phase produces a positive torque allowing pulling the rotor in the positive sense. And the second phase produces a negative torque and drags the rotor in the inverse sense. The global torque resultant of these two partial forces allows to immobilizing the rotor in an intermediate position. The gradual variations of the commutation times of the PWM control signal confers to the rotor a positioning by microsteps, [3, 4].

The control signal is synthesized by the PWM synthesizer using a programmable microprocessing control. The frequency of this signal is determined by the specific characteristics of the considered machine. The desired number of microsteps sets landings of the ratio cyclic. The PWM synthesizer is followed by an adequate logic control, which supervises the conduction and the commutation of the transistors. Thus, in order to ensure the positioning in four microsteps/steps along a one electric cycle containing four full mechanic steps, the suggested control mode allows to apply to the statoric windings two complementary signals modulated in pulse width. Further details about this control approach are provided to the bibliographic references, [5, 6, 7].

In order to demonstrate the efficiency of this digital approach, we consider the bipolar permanent stepping motor which is characterized by the principal parameters indicate in Table.1:

**Table 1.** PM Stepper motor parameters

Stator coil resistance	$R$	$32 \Omega$
Stator coil inductance	$L$	$12.2mH$
Rotor inertia	$J_0$	$6.67 \cdot 10^{-7} \text{ kg.m}^2$
Number of pair poles	$P$	4
Viscous friction constant	$D_{r0}$	$0.2 \cdot 10^{-4} \text{ m}^2 \cdot \text{s}^{-1}$
Motor torque constant	$K_\phi$	$0.03 \text{ rad.s}^{-1}$

The numerical simulation results show the relationship of the machine behavior, between the statoric currents, the rotoric speed and the angular position. Indeed, Figure 4 illustrates a fragmentation of the one mechanical step in four microsteps using a PWM technique.

The response indicated by ( $f_1$ ) is relative to the working in full steps. It shows that the movement of the considered motor is greatly oscillating and characterized by an overshoot equalizing about 30%. However, the evolution marked by ( $f_2$ ) shows that a fragmentation in 4 microsteps/step reduced considerably this overshoot and improve clearly the angular resolution.

In fact, PWM microstepping technique is an efficient solution for accurate angular resolution

using a permanent magnet stepper actuator. But the principal disadvantage of this command is the increase in the settling time, the losses electronics of commutation and the losses iron. Moreover, the motor is supplied by high frequency currents (Figures 5a and 5b) what causes a reduction in the rigidity of the magnetic and electronic circuits.

In order to solve this problem a new control approach using fuzzy logic is proposed in the next section.

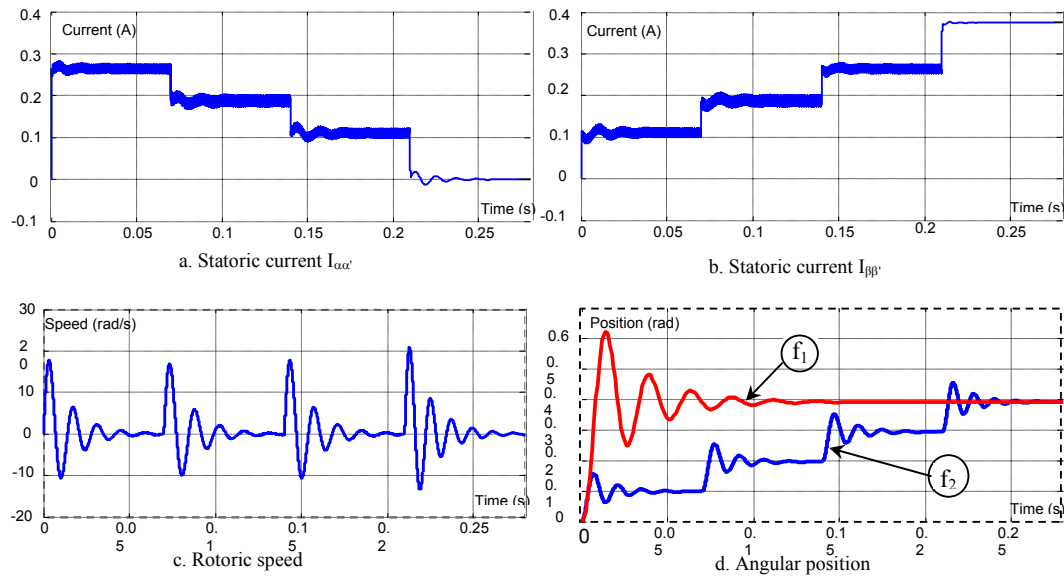

Figure 4. Fragmentation of a one step by PWM Technique

## 7. New Microstepping Concept Based on A Fuzzy Logic Technique

### 7.1 Design of the fuzzy concept

Fuzzy logic controller (FLC) is a decision algorithm based on an operator's expertise. So, this type of control strategy is described by a knowledge base and a fuzzy logic inference mechanism. The microstepping motion of the studied motor can be obtained when two successive phases are exited. Indeed, the winding  $\beta\beta'$  allows the drive of the motor and the winding  $\alpha\alpha'$  insure the braking. Hence, the inputs of the proposed FLC are the position error  $e(t)$  and the change of error  $\Delta e(t)$  defined as follow:

$$e(t) = \theta_r(t) - \theta(t) \quad (12)$$

$$\Delta e(t) = e(t) - e(t-1) \quad (13)$$

Where  $\theta(t)$  is the rotor position and  $\theta_r(t)$  is the desired equilibrium position. The output control signals of the FLC are the voltages  $U_{\alpha\alpha'}$  and  $U_{\beta\beta'}$  that should be applied to the motor windings. These signals will increase or decrease the statoric current of the studied motor.

The proposed control strategy is structured in accordance with the representation shown by Figure 5. This strategy is a closed loop control, conceived around a fuzzy logic, [8, 9].

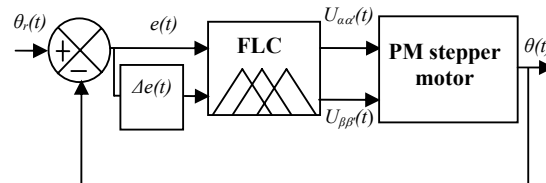
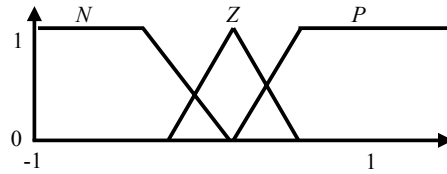

Figure 5. Closed-loop control system

A-Fuzzification

The fuzzification procedure maps the crisp input values to the linguistic fuzzy terms. For the inputs  $e(t)$  and  $\Delta e(t)$ , we used three memberships functions labeled as  $N$  (negative),  $Z$  (zero) and  $P$  (positive). These functions are normalised to the  $[-1,1]$  interval by the use of scaling factor. Membership functions that used to fuzzify the inputs are shown in Figure 6:



**Figure 6.** Normalized error and change error memberships functions

The membership functions associated with the linguistic variable error and change of error can be chosen as a series of five triangular memberships. But, the use of three functions of memberships of the triangular type led to good performances. For these reasons, paper uses these memberships functions.

B-Rule base

The rule base stores the rules governing the input output relationship of the FLC. The inference engine is responsible for decision making the control system using approximate reasoning. The rules base for this FLC is established by using the system dynamic knowledge. For example, if the error is positive and the change error is negative, then  $U_{\alpha\alpha'}$  is small and  $U_{\beta\beta'}$  is big. These rules are shown in Table 2 and Table 3.

**Table 2.** Knowledge base for the output control signal  $U_{\beta\beta'}$     **Table 3.** Knowledge base for the output control signal  $U_{\alpha\alpha'}$

		Error change						Error change			
		$N$	$Z$	$P$				$N$	$Z$	$P$	
Error	$N$	$B$	$B$	$B$		Error	$N$	$Z$	$Z$	$Z$	
	$Z$	$S$	$B$	$M$			$Z$	$M$	$Z$	$S$	
	$P$	$M$	$B$	$B$			$P$	$S$	$Z$	$Z$	

C-Defuzzification

The defuzzification procedure maps the fuzzy output from the inference engine to a crisp signal. The output variable is a constant value (singleton) independent of the values of the inputs, or a linear combination of those. The choice of singletons is easy to realize. Indeed, this method makes it possible to lead quickly to the desired results. Consequently, In order to obtain the desired microstep, we used:

- For the output signal  $U_{\alpha\alpha'}$ , a singleton memberships functions normalised in to the interval  $[\cos(\theta_j), 1]$  and labelled  $Z$  (zero),  $S$  (small),  $M$  (medium) and  $B$  (big).
- For the output signal  $U_{\beta\beta'}$ , a singleton memberships functions also normalised in to the interval  $[0, \sin(\theta_j)]$  and labelled  $Z$  (zero),  $S$  (small),  $M$  (medium) and  $B$  (big). Figure7 illustrates the outputs singletons.

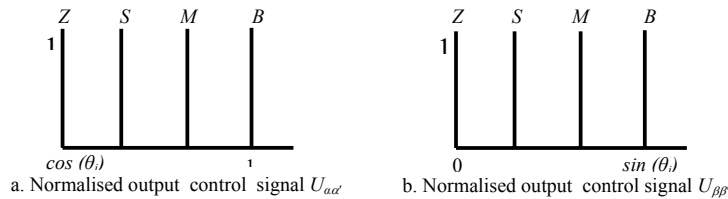

**Figure 7.** Outputs membership functions

## 7.2 Application to the improvement of the angular resolution

In the following section, we focus first on the study of the proposed fuzzy logic approach for two-positioning modes: without load and under load. In fact, the result given in Figure 8 illustrates a fragmentation of the one full mechanic step into 4 microsteps for a positioning without load.

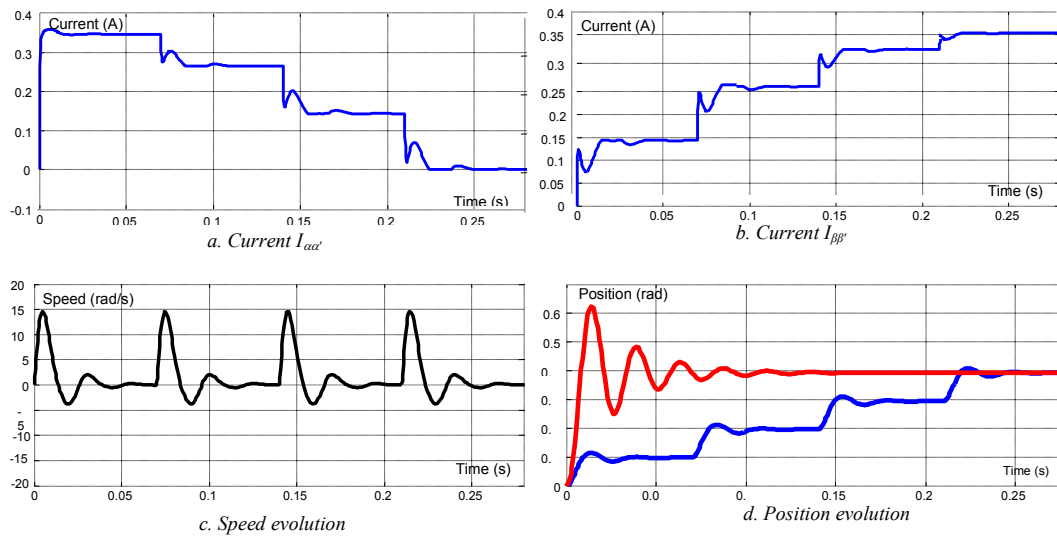

**Figure 8.** FLC- Fragmentation in 4 microsteps without load

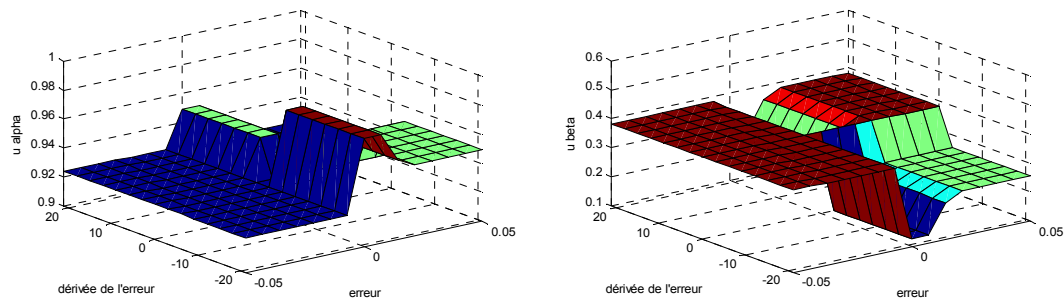
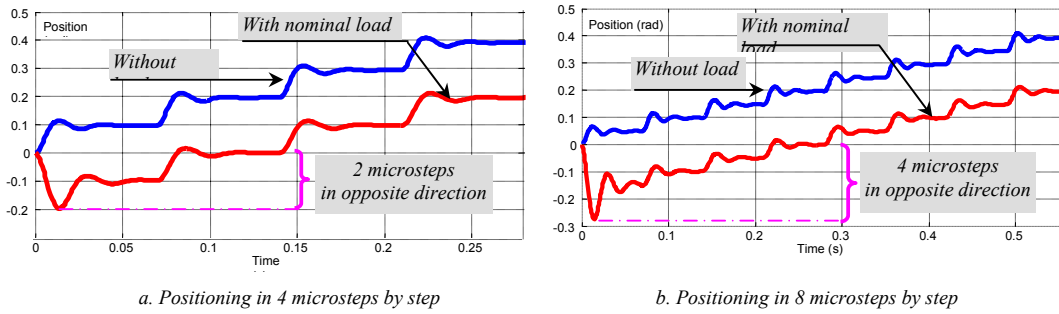

**Figure 9.** Non-linear control surface of the fuzzy model

The results given in Figure 8 and Figure 9 confirm the efficiency of the proposed fuzzy logic controller. Moreover, this FLC improve considerably the resolution and attenuates the overshoot.

To test the efficiency of this proposed FLC in positioning with load, we applied a nominal torque. It is under these conditions that the result consigned in the Figure 10 is obtained. It describes successively a positioning in 4 (Figure10a) and 8 microsteps/step (Figure10b). These responses show the appearance of an angular variation, which affects positioning in load. So, all depends on the importance of the applied load, several microsteps can be missed. In fact, when the desired number of microsteps is high and the coupled load is significant, the actuator can position in opposite direction during some step.





**Figure 10.** FLC- Fragmentation with nominal load

Generally, functioning in microstepping causes a degradation of the torque developed by the stepper motor. Moreover, the torque expression is:

$$C_{em} = -k_{\phi} [i_{\alpha} \sin(p\theta_m) - i_{\beta} \cos(p\theta_m)] \quad (14)$$

In microstepping, the currents  $I_{\alpha\alpha'}$  and  $I_{\beta\beta'}$  are given by equation (10) and (11). Then the torque expression is:

$$C_{em} = -k\phi I_n \sin(p\theta_m - \theta_j) \quad (15)$$

Where  $\theta_j$  is given by:

$$\theta_j = \frac{\pi}{2m} \quad (16)$$

With  $m$  is the number of microstep by step.

The incremental torque  $C_{inc}$  for a single microstep is defined by:

$$C_{inc} = C_M \sin\left(\frac{\pi}{2m}\right) \quad (17)$$

The exploitation of these equations leads to the result consigned in Figure 11:

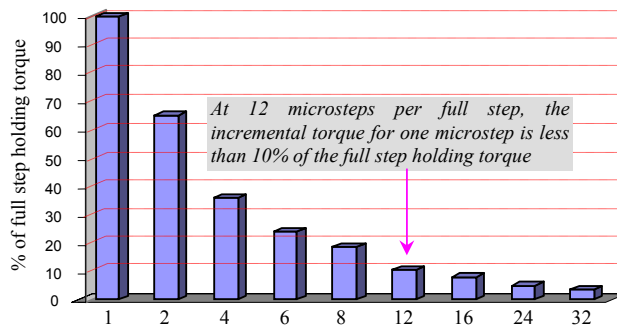
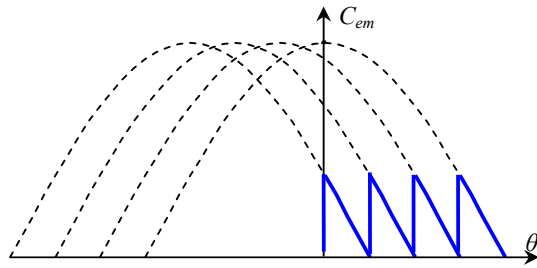

**Figure 11.** Histogram of incremental torque evolution

The consequence is that if the load torque plus the motor's friction and detent torque is greater than the incremental torque of a microstep, successive microsteps will have to be realized until the accumulated torque exceeds the load torque plus the motor's friction and detent torque.

This histogram quantifies the significant impact of the incremental torque per microstep as a function of the number of microsteps per full step.

Thus, without load, fragmentation is regular leading to equality between the amplitudes of the all microsteps, Figure 12:



**Figure 12.** Static torque curves in microsteps positioning without load

This deduction is confirmed by the results of the Figure 8. But, a simply stated, taking a microstep does not mean the motor will actually move, and if reversing direction is desired a whopping number of microsteps may be needed before movement occurs, Figure 13:

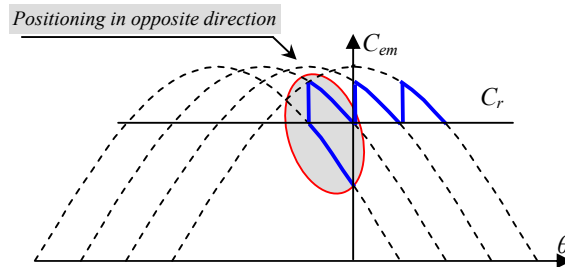

**Figure 13.** Static torque curves in microsteps positioning with nominal load

That's because the motor shaft torque must be decremented from whatever positive value it has to negative value that will have sufficient torque to cause motion in the negative direction.

This undesirable positioning is confirmed by the simulation tests, which are consigned in precedents Figure 10.

To solve this problem, a correction approach is proposed in the next section.

### 7.3 Correction of the positioning error

#### A. Basic idea

In positioning with load, the equilibrium is reached by the equality between the torque machine  $C_{em}$  and the torque  $C_r$  opposed by the coupled load. The satisfaction of this condition reveals an inaccuracy, which affects the precision positioning. The study in static mode of the torque angular curves, Figure 14, shows that the positions reached by the rotor under load, presents a positioning error ( $\Delta\theta$ ).

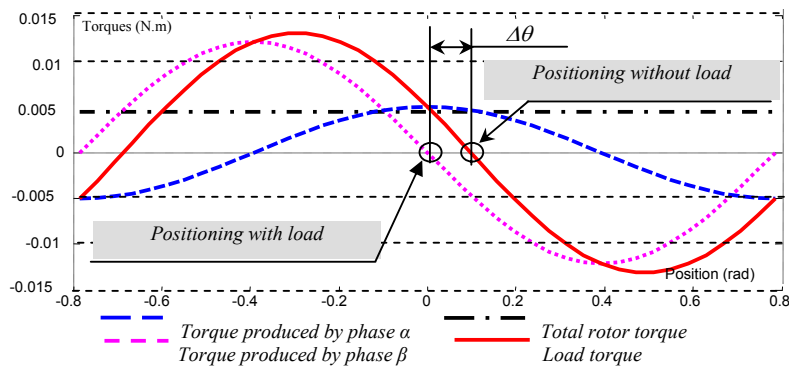

**Figure 14.** Description of the positioning error

In fact, the equilibrium is reached with the equality between the motor torque and resistant torque, it comes then:

$$C_{em} = -k_{\phi} I_n \sin(p\theta_m - \theta_j) = C_r \quad (18)$$

That is to say:

$$\Delta\theta = \arcsin\left(\frac{C_r}{k_{\phi} I_n}\right) \quad (19)$$

The basic idea consists to slip the global static torque curve so that the point M coincides with the point M<sub>0</sub>. This operation can be realized by the action on the partial torques, which are produced by the actives phases  $\alpha\alpha'$  and  $\beta\beta'$ . This adjustment is conditioned by a judiciously controlled imbalance between the statoric currents. So, the stator excitation is regulated by the following relations

$$I_{\alpha} = I_n \cos(\theta_j + \Delta\theta) \quad (20)$$

$$I_{\beta} = I_n \sin(\theta_j + \Delta\theta) \quad (21)$$

In this case, the new defuzzification procedure consists on the generation of a singleton memberships functions from the two output signals  $U_{\alpha\alpha'}$  and  $U_{\beta\beta'}$  respectively normalised into the interval  $[\cos(\theta_j + \Delta\theta) \ 1]$  and  $[0 \ \sin(\theta_j + \Delta\theta)]$ .

### B. Simulation results

The integration of this correction module to the principal simulation programme, led to the results consigned in the Figure15. These results show the potentiality of this new defuzzification approach in the improvement of the positioning precision with variable load.

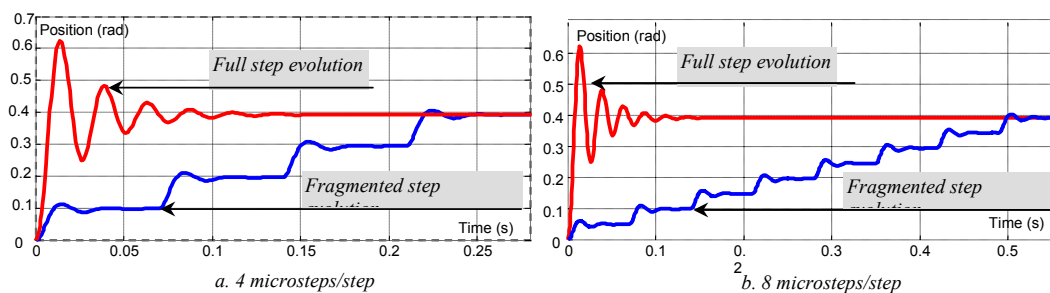

Figure 15. FLC-corrected positioning in half nominal load

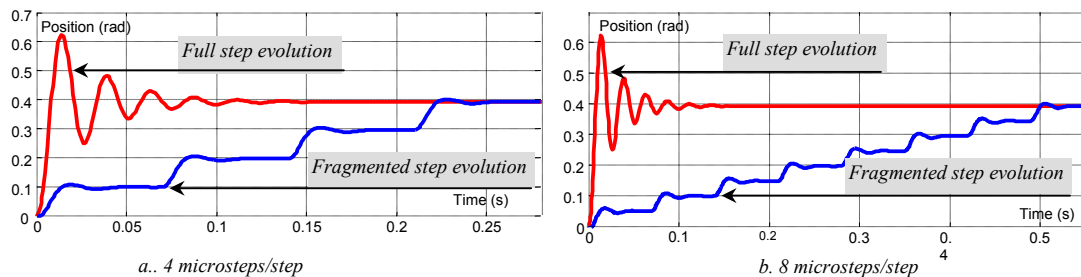

Figure 16. FLC-Corrected positioning in nominal load

## 8. Conclusion

In this paper, a closed loop Fuzzy Logic Controller and a modelling approach are proposed for a permanent magnet stepper actuator. This strategy have the advantage to convert a conventional permanent magnet stepping machine with a fixed step-size into one with a programmable step angle, thereby improving motor positioning resolution by a high factor.

Also, this control approach attenuates, in a very much reduced settling time, the oscillations and eliminates the problems of overshoot and resonance. Hence, this method contributes to the improvement of the dynamic stability of a PM stepper machine functioning in lower speed.

## REFERENCES

1. KANT, M. and VILAIN J. P., **Modélisation dynamique du moteur pas à pas**, Revue de Physique Appliquée, No. 7, 1990, pp. 687-692.
2. JURER, M., **Electromécanique**, Édition Géorgie, 1979.
3. MICROMO ELECTRONICS, INC, **Microstepping Myths and Realities**.
4. TEXAS INSTRUMENTS INCORPORATED, **A High Precision PWM Transconductance Amplifier for Microstepping Using Unitrode's UC3637**, Unitrode Application Note, 1999.
5. BEN SALAH, B., **Contribution à la conception, la réalisation, l'analyse et la commande de machines électriques**, Mémoire d'Habilitation Universitaire en Génie Electrique, ENIT-Tunisia, 2003.
6. BEN SALAH, B., MHATLI K. and BEN SAAD K, **A New Digital Control for Improving the Position Resolution of Linear Stepping Switched Reluctance Machine**, International Review of Electrical Engineering (I.R.E.E), ISSN 1827-6660, Vol.2, N°.1, January-February 2007, PP. 127-135.
7. BEN SAAD, K., **Modélisation et commande d'un moteur pas à pas tubulaire à réluctance variable et à quatre phases- Approches conventionnelles, par logique floue et par réseaux de neurones artificiels**, Thèse de Doctorat en Génie Electrique, ENIT-Tunisia, 2005.
8. BEN SAAD, K., BEN SALAH B., BENREJEB M. and BROCHET P., **Fuzzy Logic Controller for Switched Reluctance Linear Stepping Motors**, TRANSACTIONS ON Systems, Signals & Devices, ISSN : 1861-5252, Vol.1, N°. 1, 2005-2006 pp.69-84.
9. BEN SAAD, K., BEN SALAH B., BENREJEB M. and BROCHET P., **Neuronal modelling fuzzy control of switched reluctance tubular stepping motor**, 17th IMACS, World Congress on Scientific Computation, Applied Mathematics and Simulation, Paris-France, July 11-15, 2005.